

LUX CABIN, MINIMALISTA

LUX CABIN
COTIZACION N° 1842067

MARIA JOSE GIL
m.gil@mk.cl | +569 5229 0258



GRUPO K

arquitectura



PISO GENERAL

PISO VINILICO

AURORA CEMENT LIGHT GREY

PDV-20-0685

- Piso vinílico LVT
- 950x184x3/0.3mm
- Clasificación del suelo 31
- Instalación pegada

KLIPEN





COMPLEMENTOS

PISO VINILICO SPC



GUARDAPOLVO MANDALA BEIGE
MDC-19-0129



COLOR
MANDALA BEIGE



CUBREJUNTA COMPENSACIÓN MANDALA BEIGE
12x38x2400mm
MDC-19-0131



CUBREJUNTA TRANSICIÓN MANDALA BEIGE
9x45x2400mm
MDC-19-0133



JUNQUILLO MANDALA BEIGE
15x15x2400mm
MDC-19-0130



COMPLEMENTOS

PISO VINILICO SPC



COLOR
MANDALA BEIGE



CUBREJUNTA TRANSICIÓN MANDALA BEIGE PVC

7x45x2400mm

PDV-20-0240



CUBREJUNTA COMPENSACIÓN MANDALA BEIGE PVC

7x45x2400mm

PDV-20-0244

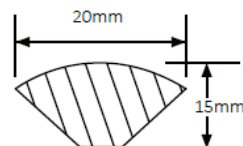

GUARDAPOLVO MANDALA BEIGE PVC

15x90x2400mm

PDV-20-0289



JUNQUILLO MANDALA BEIGE PVC

PDV-20-0236



MURO BAÑOS

PANEL SPC

RIVIERA WOOD NATURAL

KLR-62-0098

- Panel Alveolar SPC
- 2900x400x8mm
- Biselado
- Fabricado con 60% de policloruro de vinil, 30% carbonato de calcio y 10% de polímeros.





RECEPTACULO SIN PESTAÑA

RECEPTACULO ZEN CON REJILLA A 16 CM 1400X700

HID-05-0226

- Receptáculo de ducha con antideslizante
- Material: Acrílico reforzado en fibra de vidrio
- Espesor: 4 mm (Acrílico +Fibra)
- Resistencia: 150 kgs.

Incluye:

- Desagüe cromado registrable
- Descarga 30 lpm aprox.
- Estructura de fierro con patas ajustables
- Tuerca de fijación de ajuste en cada pata
- 1 Rejilla para registro que puede ser instalada a la derecha o izquierda.
- Posición rejilla: a 160 mm del borde del receptáculo.
- Diámetro conexión 50 mm



KLIPEN

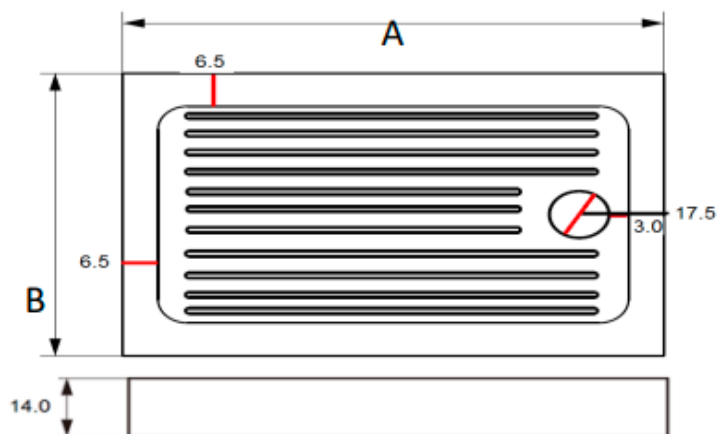

Medidas	Patas (PCS)
700X700	4 PCS
800X800	4 PCS
900X900	4 PCS
900X700	4 PCS
1000x700	4 PCS
1000x900	4 PCS
1100X700	6 PCS
1100x800	6 PCS
1100X1200	6 PCS

Medidas	Patas (PCS)
1200X700	6 PCS
1200X800	6 PCS
1200x900	6 PCS
1300X700	6 PCS
1300x800	6 PCS
1400X700	6 PCS
1400X800	6 PCS
1500X700	6 PCS
1500X800	6 PCS

Medidas	Patas (PCS)
1600X700	6PCS
1600X800	6PCS
1600x900	6PCS
1700X700	6PCS
1700x800	6PCS
1700X900	6PCS
1800X900	6PCS
2000x800	6PCS
2000x900	6PCS



MAMPARA

STYLE

MAMPARA STYLE FIJA RECEP 80

HID-36-0053

- Mampara Fija
- Espesor 8 mm
- Vidrio templado
- Incluye fijaciones
- Marcos terminación Cromo
- *Brazo de instalación opcional
- No incluye Receptáculo

SKU	Medidas	
	A	B
HID-36-0053	800	1980
HID-36-0013	1000	1980

KLIPEN

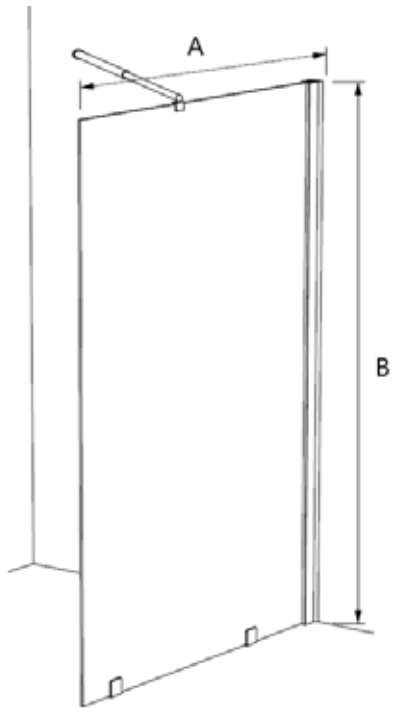



GRIFERIA

LAVAMANOS

GRIFERIA LAVAMANOS BOSTON 7 CM S/DESAGÜE CROMO

GKL-03-0792

- Grifería monomando de lavamanos
- Modelo: BOSTON
- Terminación: CROMO
- Sin desagüe
- Material: Latón
- Cartucho cerámico: 35 mm
- Aireador: Aireador de plástico local
- Medidas 150.5x137.8mm
- Largo flexibles: 400mm
- Conexión: 1/2"

KLIPEN

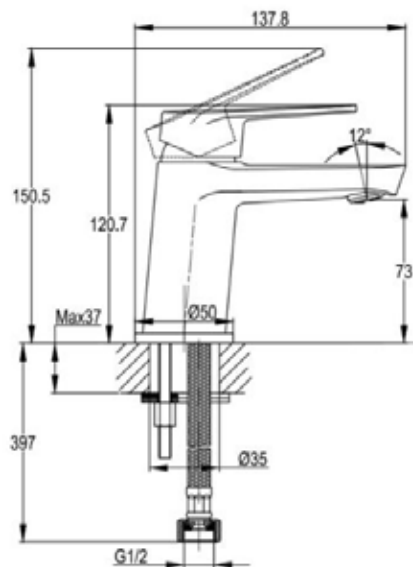



GRIFERIA

DUCHA

GRIFERIA DUCHA BOSTON EXPUESTA CROMO

GKL-03-0798

- Monomando de ducha
- Modelo: BOSTON
- Terminación: CROMO
- Material: Latón
- Cartucho cerámico: 35 mm
- Aireador: Aireador de plástico local
- Medidas: 109x150x100mm
- Conexión: 1/2" para flexible

 KLIPEN

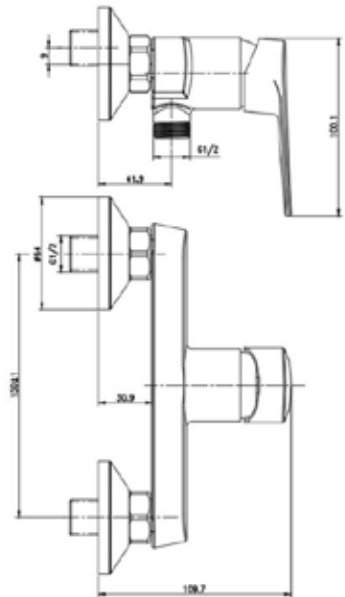



GRIFERIA

DUCHA

GRIFERIA DUCHA TINA BOSTON EXPUESTA CROMO

GKL-03-0796

- Monomando de ducha
- Modelo: BOSTON
- Terminación: CROMO
- Material: Latón
- Cartucho cerámico: 35 mm
- Aireador: Aireador de plástico local
- Medidas: 150x61.3x171.36mm
- Conexión: 1/2" para flexible

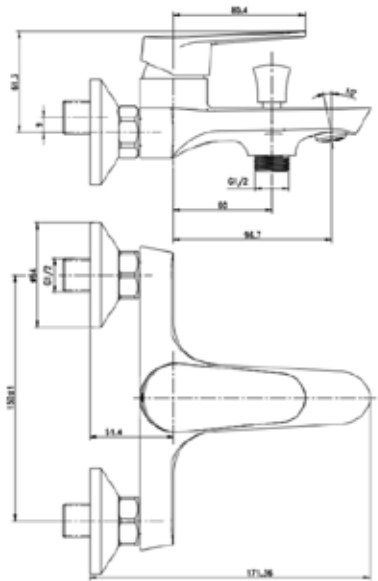

SET SOPORTE DUCHA TRENTO CROMO

GKL-03-0008



COCINA

GRIFERIA LAVAPLATOS

GRIFERIA COCINA BOSTON 1 JET CROMO

GKL-03-0800

- Monomando de cocina cuello cisne
- Modelo: BOSTON
- Terminación: CROMO
- Material: Latón
- Cartucho cerámico: 35 mm
- Aireador: Aireador de plástico local
- Medidas: 311x45x223mm
- Conexión: ½" para flexible



IMAGEN REFERENCIAL

Especificaciones técnicas:

VOXNAN

Grifería para lavamanos
Color: Cromado

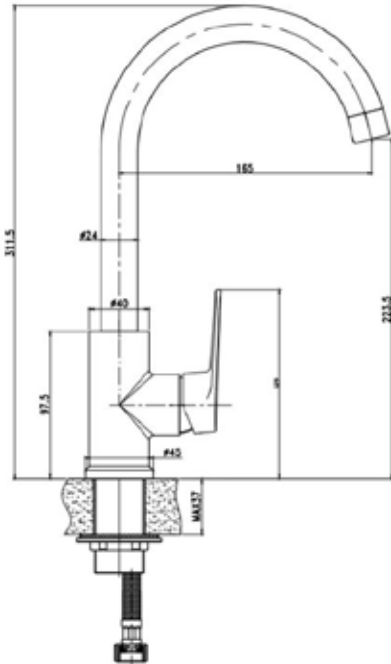